

NOTES:  
 CABINET BUILT OF .134 THK CRS  
 WITH GREY COAT FINISH.

**PROPRIETARY  
 PROPOSAL**

**\*\* PROPRIETARY AND CONFIDENTIAL \*\***

THIS DOCUMENT AND THE INFORMATION  
 HEREIN IS THE SOLE PROPERTY OF  
 SUN WEST ENGINEERING INC.  
 DUPLICATION OF THIS INFORMATION WITHOUT  
 PRIOR CONSENT OF SUN WEST ENGINEERING  
 IS FORBIDDEN.

		<b>SUN WEST ENGINEERING, INC.</b> <small>3802 E. BROADWAY, PHOENIX, AZ 85040 (602) 275-0662</small>	
		TITLE: BATTERY RACK ZONE 4	
CUSTOMER:			
PLOTTED SCALE: .XXXX=1	SHEET: 1 of 1		
DRAWN BY: <i>WV</i>	DATE DRAWN: 6-8-11		
REVISED:	DWG. No. SW-3762		

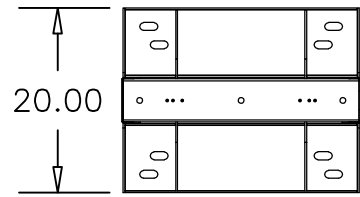

TOP VIEW

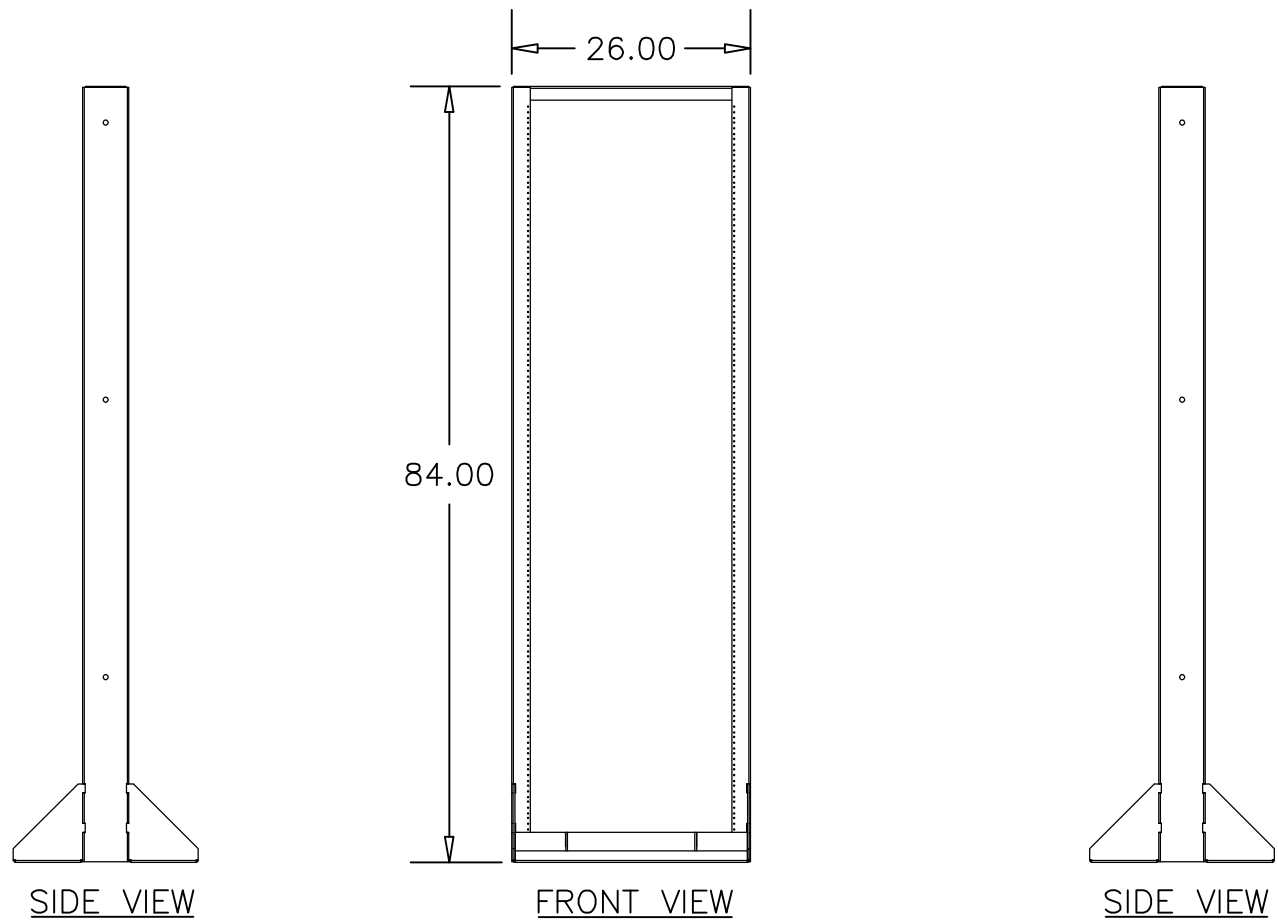

SIDE VIEW

FRONT VIEW

SIDE VIEW

NOTES:  
 CABINET BUILT OF .134 THK CRS  
 WITH GREY COAT FINISH.

**PROPRIETARY  
 PROPOSAL**

**\*\* PROPRIETARY AND CONFIDENTIAL \*\***  
 THIS DOCUMENT AND THE INFORMATION  
 HEREIN IS THE SOLE PROPERTY OF  
 SUN WEST ENGINEERING INC.  
 DUPLICATION OF THIS INFORMATION WITHOUT  
 PRIOR CONSENT OF SUN WEST ENGINEERING  
 IS FORBIDDEN.

		<b>SUN WEST ENGINEERING, INC.</b> <small>3802 E. BROADWAY, PHOENIX, AZ 85040 (602) 275-0662</small>	
		TITLE: BATTERY RACK ZONE 4	
CUSTOMER:			
PLOTTED SCALE: .XXXX=1	SHEET: 1 of 1		
DRAWN BY: <i>WV</i>	DATE DRAWN: 6-8-11		
REVISED:	DWG. No. SW-3763		

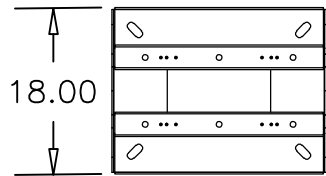

TOP VIEW

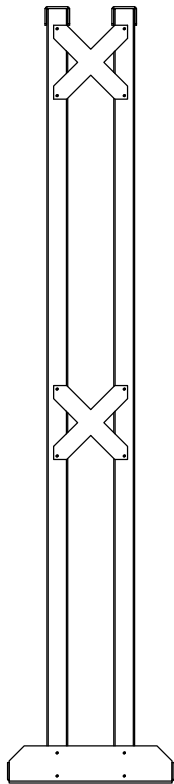

SIDE VIEW

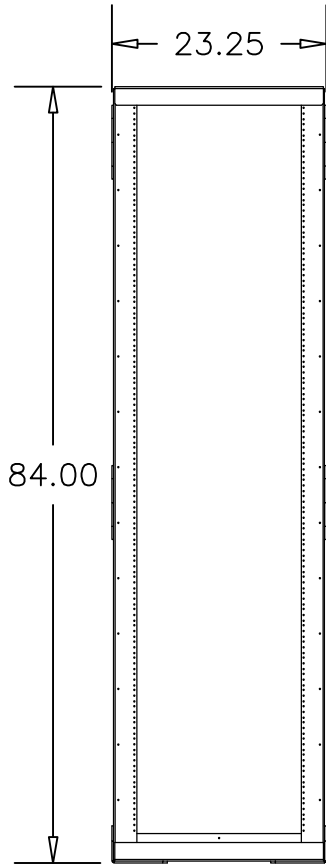

FRONT VIEW

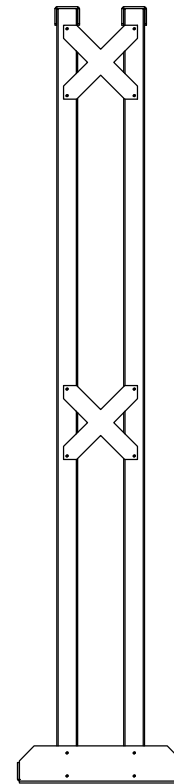

SIDE VIEW

NOTES:  
 CABINET BUILT OF .134 THK CRS  
 WITH GREY COAT FINISH.

**PROPRIETARY  
 PROPOSAL**

**\*\* PROPRIETARY AND CONFIDENTIAL \*\***

THIS DOCUMENT AND THE INFORMATION  
 HEREIN IS THE SOLE PROPERTY OF  
 SUN WEST ENGINEERING INC.  
 DUPLICATION OF THIS INFORMATION WITHOUT  
 PRIOR CONSENT OF SUN WEST ENGINEERING  
 IS FORBIDDEN.



**SUN WEST ENGINEERING, INC.**  
 3802 E. BROADWAY, PHOENIX, AZ 85040 (602) 275-0662

TITLE: ENODE RACK  
 ZONE 4

CUSTOMER:

PLOTTED SCALE: .XXXX=1 SHEET: 1 of 1

DRAWN BY: *WV* DATE DRAWN: 6-8-11

REVISED: DWG. No. SW-3764