

FRONT VIEW
(DOOR REMOVED)

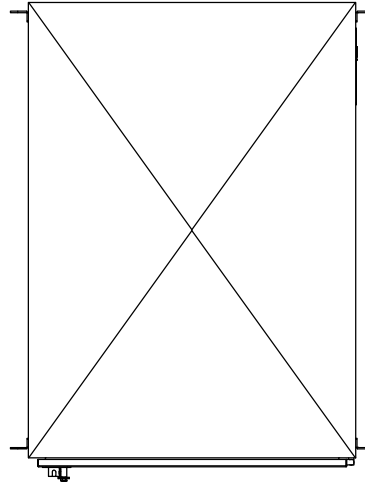

TOP VIEW

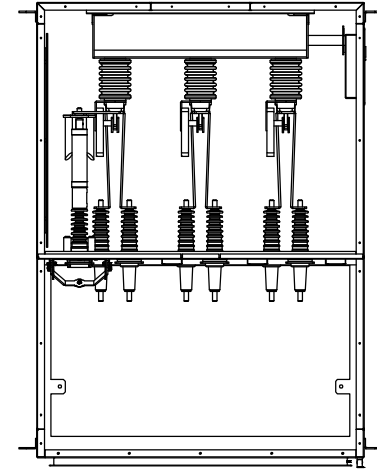

TOP VIEW
(ROOF REMOVED)

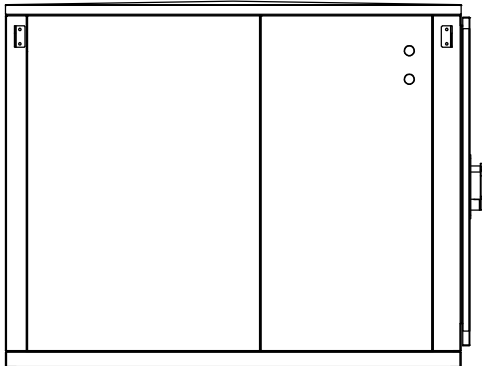

END VIEW

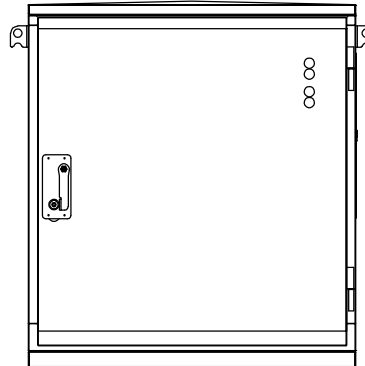

FRONT VIEW

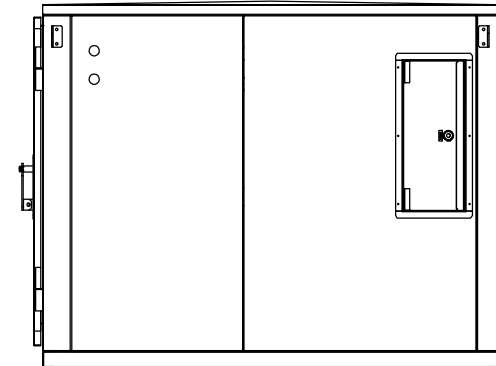

END VIEW

**PROPRIETARY
PROPOSAL**

THIS DOCUMENT AND THE INFORMATION
HEREIN IS THE SOLE PROPERTY OF
SUN WEST ENGINEERING INC.
DUPLICATION OF THIS INFORMATION WITHOUT
PRIOR CONSENT OF SUN WEST ENGINEERING
IS FORBIDDEN.



SUN WEST ENGINEERING, INC.	
3802 E. BROADWAY, PHOENIX, AZ 85040 (802) 275-0862	
TITLE: SWITCH CABINET	
CUSTOMER:	
PLOTTED SCALE: .XXXX=1	SHEET: 1 of 1
DRAWN BY: <i>HJM</i>	DATE DRAWN: 11-5-11
REVISED:	DWG. No. SW-3937

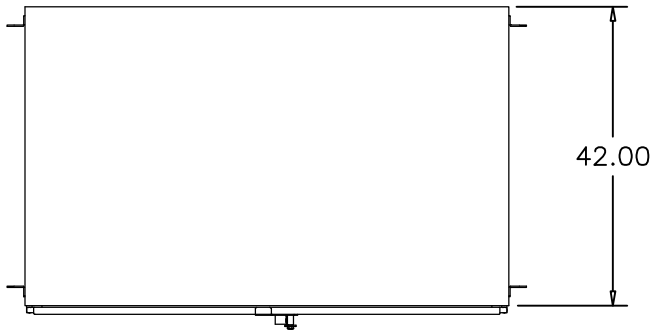
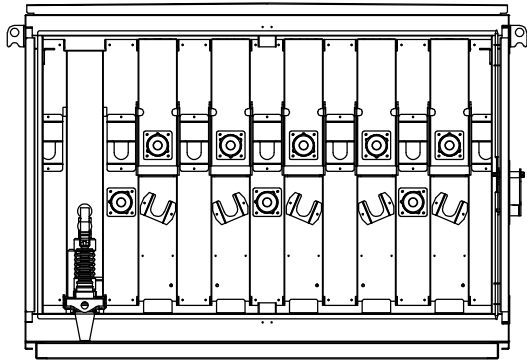

TOP VIEW

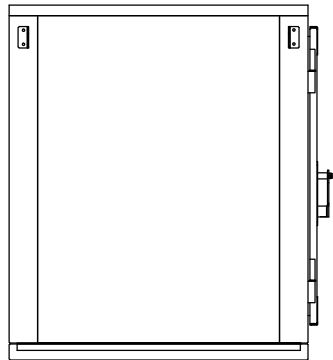
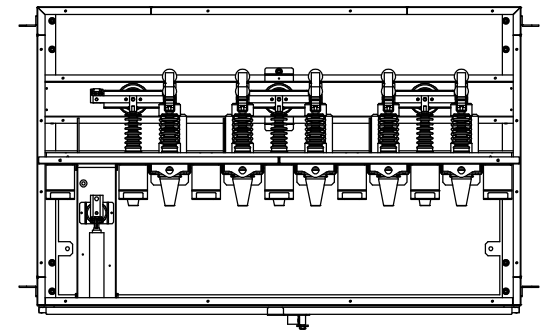

END VIEW

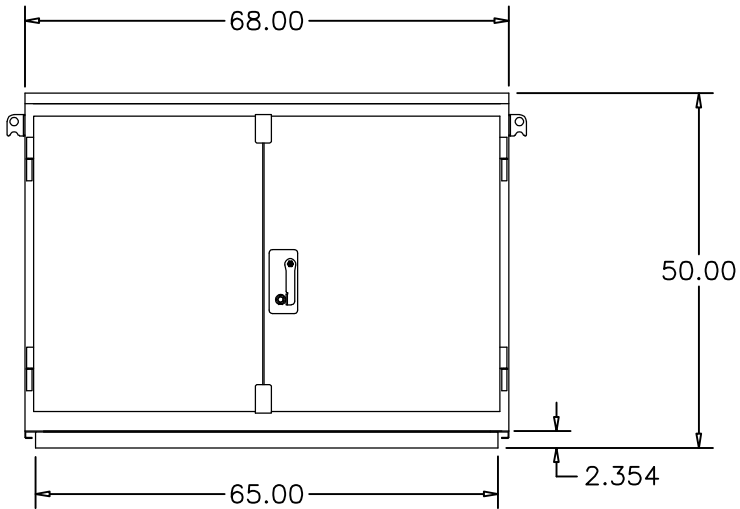

FRONT VIEW

**PROPRIETARY
PROPOSAL**

THIS DOCUMENT AND THE INFORMATION
HEREIN IS THE SOLE PROPERTY OF
SUN WEST ENGINEERING INC.
DUPLICATION OF THIS INFORMATION WITHOUT
PRIOR CONSENT OF SUN WEST ENGINEERING
IS FORBIDDEN.



SUN WEST ENGINEERING, INC.
3802 E. BROADWAY, PHOENIX, AZ 85040 (802) 275-0662

TITLE:
DEAD FRONT FUSING ENCLOSUER

CUSTOMER:

PLOTTED SCALE: .XXXX=1 SHEET: 1 of 1

DRAWN BY: *HJM* DATE DRAWN: 11-5-11

REVISED: DWG. No. SW-3938

TOP VIEW

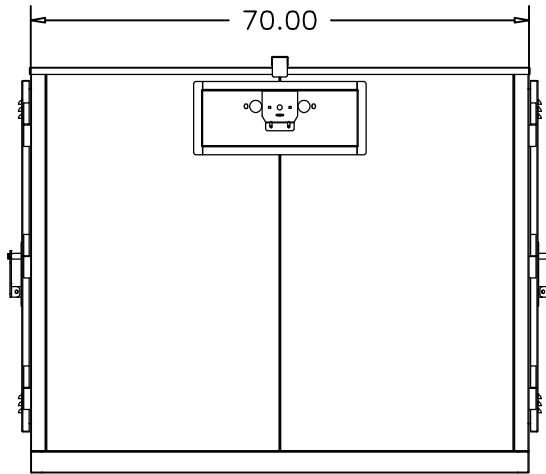
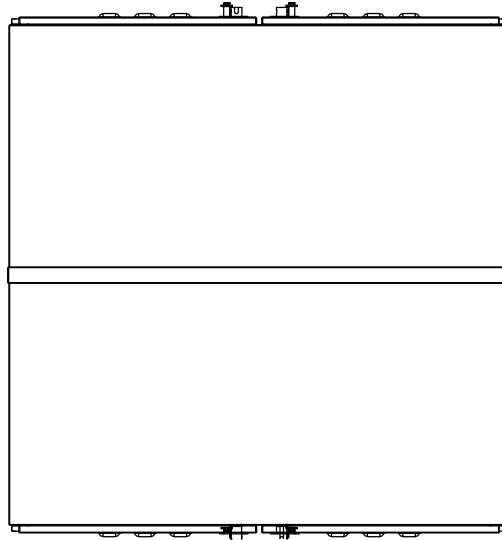

END VIEW

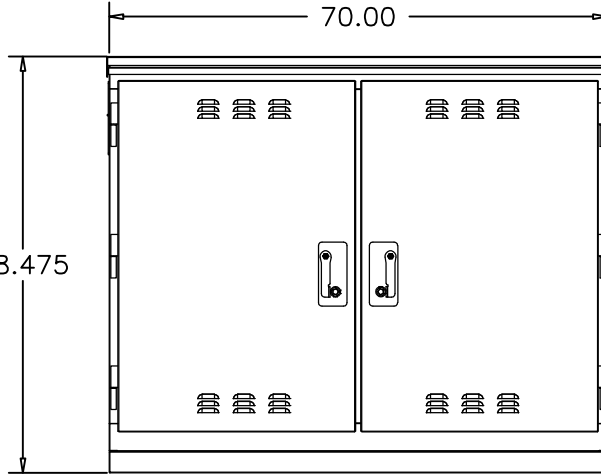

FRONT VIEW

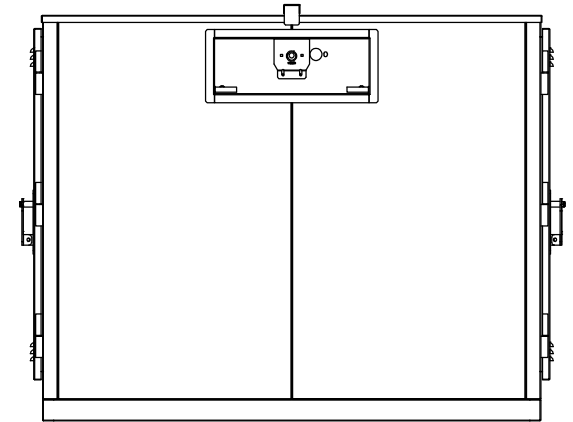

END VIEW

**PROPRIETARY
PROPOSAL** 

THIS DOCUMENT AND THE INFORMATION
HEREIN IS THE SOLE PROPERTY OF
SUN WEST ENGINEERING INC.
DUPLICATION OF THIS INFORMATION WITHOUT
PRIOR CONSENT OF SUN WEST ENGINEERING
IS FORBIDDEN.



SUN WEST ENGINEERING, INC. 3802 E. BROADWAY, PHOENIX, AZ 85040 (802) 275-0662	
TITLE: CLP-615 SWITCH CABINET	
CUSTOMER:	
PLOTTED SCALE: .XXXX=1	SHEET: 1 of 1
DRAWN BY: <i>HJM</i>	DATE DRAWN: 11-10-11
REVISED:	DWG. No. SW-3942

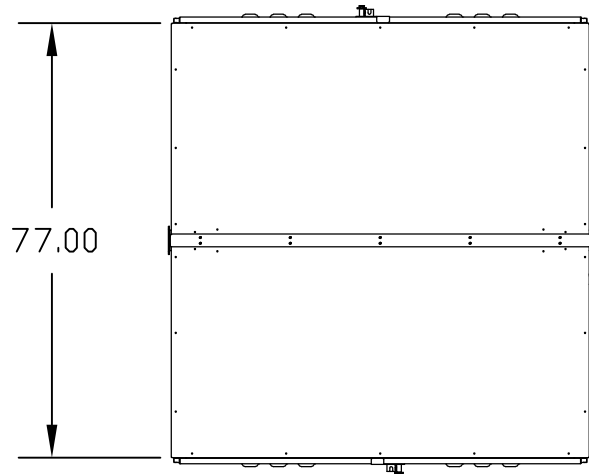

TOP VIEW

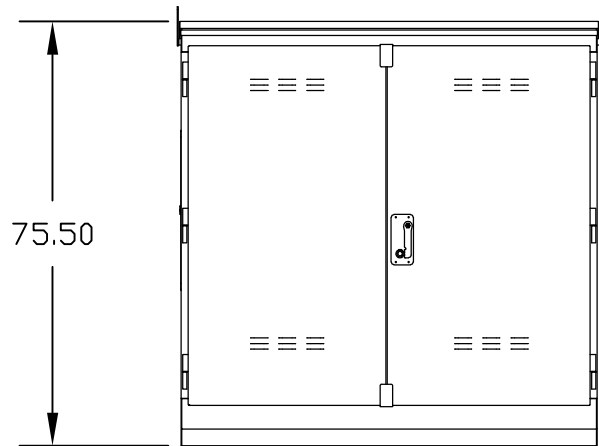

FRONT VIEW

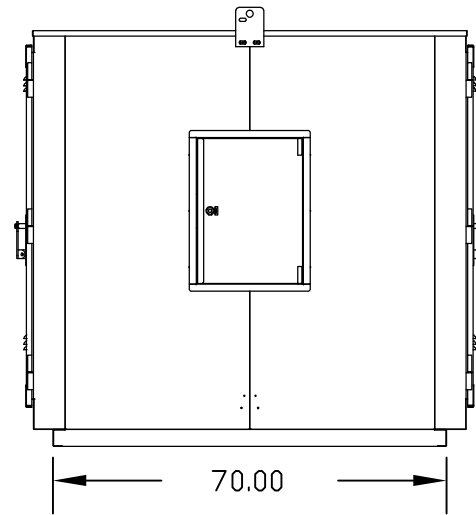

SIDE VIEW

**PROPRIETARY
PROPOSAL**

THIS DOCUMENT AND THE INFORMATION
HEREIN IS THE SOLE PROPERTY OF
SUN WEST ENGINEERING INC.
DUPLICATION OF THIS INFORMATION WITHOUT
PRIOR CONSENT OF SUN WEST ENGINEERING
IS FORBIDDEN.

		SUN WEST ENGINEERING, INC. <small>3802 E. BROADWAY, PHOENIX, AZ. 85040 (602) 276-0662</small>	
		TITLE: STEALTH CABINET	
CUSTOMER:			
PLOTTED SCALE: 1=1	SHEET: 1 OF 1		
DRAWN BY: <i>SCM</i>	DATE DRAWN: 11-5-11		
REVISED:	DWG. No. SW-3936		